

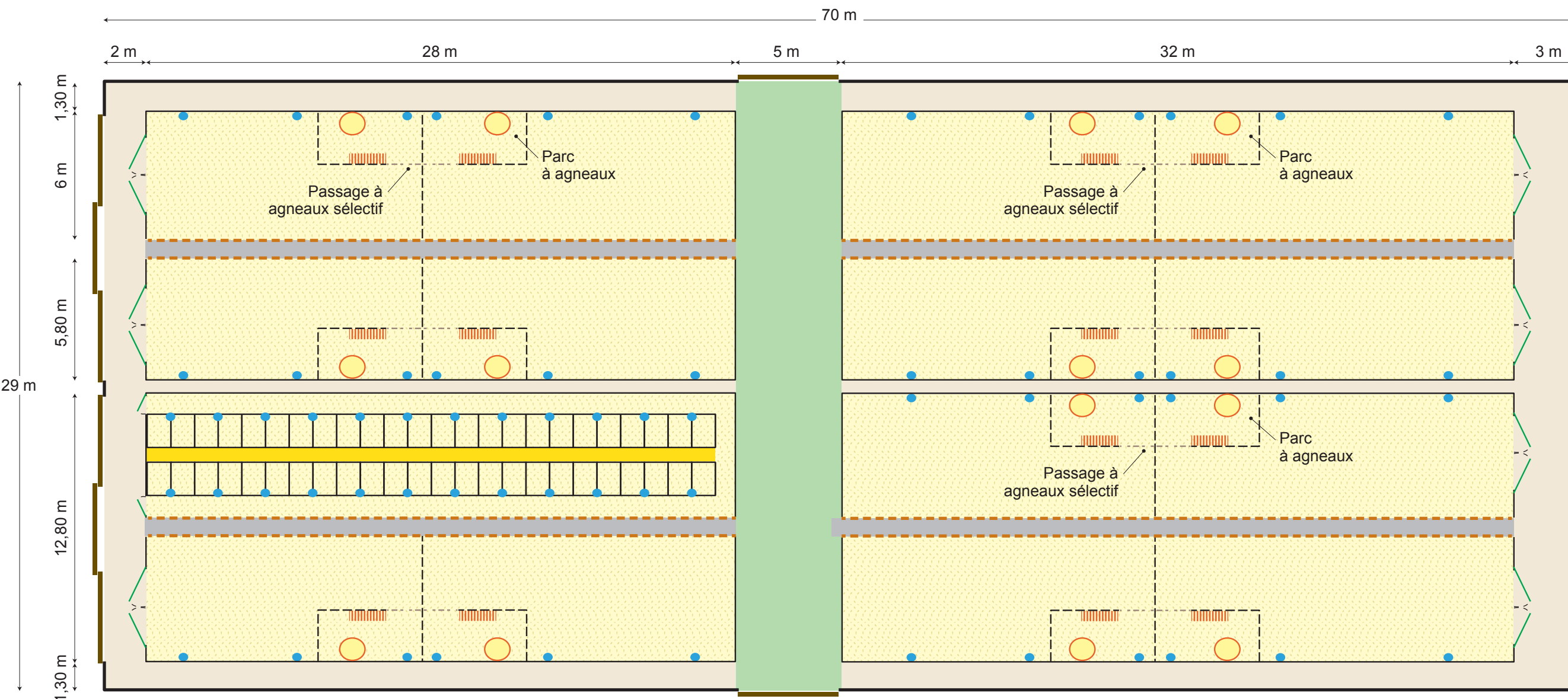





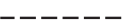

Une bergerie de 29 m de large

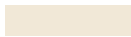

-  Aire paillée
-  Auge mécanique avec cornadis
-  Abreuvoir
-  Portes coulissantes
-  Coulloir d'alimentation
-  Ratelier
-  Nourrisseur agneaux
-  Foin en libre service
-  Séparations amovibles
-  Coulloir de circulation (homme et animaux)